



The #1 Source for Donut and Bakery Equipment

www.belshaw.com

# OPERATOR'S MANUAL TECHNICAL SUPPLEMENT PARTS AND ELECTRICAL DIAGRAMS



Manufactured  
**2018**  
or later

Photo: Belshaw  
724CG Gas Fryer  
shown with Type F  
Depositor and EZMelt  
24 Melter-Filter.

# 718LCG-724CG-734CG

Donut Fryer • Gas Heated • Electronic Ignition

ITEM NUMBER

SERIAL NUMBER

*Item Number / Serial Number are listed on a data tag attached to the equipment.  
This manual should only be used with the Item Number(s) shown above.*



## SUPPORT

**USA/Canada** 1-800-578-2547  
**International** (+1) 206-322-5474

**Email** [service@belshaw.com](mailto:service@belshaw.com)  
**Web** [www.belshaw.com](http://www.belshaw.com)



*Belshaw*<sup>®</sup>

Open Kettle Gas Fryers  
718LCG, 724CG & 734CG

Operator's Manual

Belshaw Adamatic Bakery Group.  
814 44<sup>th</sup> Street Northwest, Suite 103  
Auburn, WA 98001 USA  
Phone: (206) 322-5474 • Fax: (206) 322-5425  
E-mail: [service@belshaw.com](mailto:service@belshaw.com) • [www.belshaw.com](http://www.belshaw.com)

**BELSHAW-ADAMATIC FREIGHT  
DAMAGE POLICY**

Belshaw-Adamatic has made every effort to insure that your equipment arrives in good condition. **For your protection**, please inspect your shipment for any signs of damage that may have occurred during transport. Please note any damage that is found during inspection and file a freight claim with the shipping company immediately. Acceptance of damaged equipment may become the responsibility of the acceptor.

**Please read the section “Shipping Damage and Missing Items” in the Warranty at the back of this manual.**

To unpack the fryer and transport it to the workstation:

1. Use a fork lift to transport the shipping crate to the work station.
2. Break down the shipping crate.
3. Remove all the packing materials from the fryer. These include foam, tape, brown paper, plastic, and white protective coating.
4. Position the fryer to allow sufficient space on either end of the machine for any equipment you plan to use with it.

<b>IMPORTANT</b>
<b>Keep this manual for future reference.</b>

<b>EQUIPMENT RECORD</b>	
Please provide the information below when you correspond with us about your machine.	
Purchased by	_____
Installed by	_____
Date of Installation	_____
Model number	_____
Serial number	_____

111516  
MN-1142EN  
Belshaw Adamatic Bakery Group.  
814 44<sup>th</sup> Street Northwest, Suite 103  
Auburn, WA 98001 USA  
Phone: (206) 322-5474 • Fax: (206) 322-5425  
E-mail: [service@belshaw.com](mailto:service@belshaw.com) • [www.belshaw.com](http://www.belshaw.com)

# Contents

<b>Preface</b>	<b>iv</b>
<b>1 Operation</b>	<b>1</b>
Taking Safety Precautions	1
Filling with Shortening	1
If the Pilot Light Fails to Ignite	2
High Temperature Limit Switch	2
Adding Shortening to the Fryer	2
Fill up to "OIL LEVEL" Marks	3
<b>2 Cleaning</b>	<b>4</b>
Removing the Shortening	4
Washing	5
Rinsing	5
<b>3 Donut-Making Helps</b>	<b>7</b>
Tips on Making Quality Cake Donuts	7
Calculating Correct Water Temperature	8
Ratios of Plunger Sizes to Donut Weights	8
Temperature Conversion	8
<b>3 Donut-Making Helps</b>	<b>7</b>
Tips on Making Quality Cake Donuts	7
Calculating Correct Water Temperature	8
Ratios of Plunger Sizes to Donut Weights	8
Temperature Conversion	8

# Preface

The 718LCG, 724CG, and 734CG Gas Fryers are designed to fry cake and yeast-raised donut products. Each must be bolted to a flat, dry floor. The operator should stand opposite the flue stack.

The operator must work safely at all times and read this manual and follow its instructions and warnings. A thorough understanding of how to install, maintain, and safely operate the fryer will prevent production delays and injuries.

Heed the following warnings and all other warnings that appear in this manual:

- Make sure the machine is bolted securely to the floor. Doing so will prevent the machine from moving, tipping, or falling, which could cause serious injury.
- Never let water and hot shortening come in contact with each other. Moisture causes hot shortening to spatter, which may cause serious burns.
- Do not overfill the kettle with shortening. If shortening overflows the kettle, it could cause serious burns or could cause someone to slip on the floor and be seriously injured.
- Hot shortening can cause serious burns. Make sure that the system and the shortening are cool before attempting any cleaning, adjustment, disassembly, or repair.
- To avoid electrocution or other injury, unplug the machine before attempting any cleaning, adjustment, disassembly, or repair.
- To avoid damaging the machine, never use force to assemble, disassemble, operate, clean, or maintain it.
- Be careful never to get shortening, water, or other materials on the floor. If anything does

get spilled on the floor, mop it up immediately. Materials on the floor can cause people to slip or fall, resulting in serious injury or loss of life.

- To prevent unintentional startup and possible fire, unplug the machine if there is a local power outage. When the power is restored, it is safe to plug the machine in again.
- To avoid electrocution, make sure that all electrical cords are not frayed or cracked and that they do not pass through any water or shortening.
- Make sure that all electrical cords are routed so that no one will trip over them.
- Make sure you are aware of the following:

This product contains chemicals known to the State of California to cause birth defects or other reproductive harm. Operation, installation and servicing of this product could expose you to carbon monoxide if not adjusted properly. Inhalation of carbon monoxide is known to the State of California to cause birth defects or other reproductive harm.

Maintenance and repairs shall only be carried out by a factory representative or qualified service personnel.

- Liquid Propane fryers  
Liquid propane models are designed for use with a secure commercially installed propane tank located remotely from your fryer. Do not use with a portable propane tank.
- LPG/LNG Conversion  
Contact the Factory to obtain necessary parts and instructions.

## Taking Safety Precautions

In a prominent location, post information about what to do if there is a gas leak. Make sure that all employees know what to do.

### WARNING

To avoid the possibility of fire, explosion, property damage, serious burns, and even death, never store gasoline or any other flammable liquid or vapor near the fryer.

### WARNING

To avoid serious injury or death, if you smell gas or suspect a gas leak, proceed as follows: 1. Turn off the gas. 2. Evacuate the building. 3. Do not touch any electrical switch or telephone until you are sure no spilled gas remains.

## Filling with Shortening

### WARNING

To avoid serious injury or death, before you begin working, make sure that there is no combustible material in the area of the fryer.

**Read** each step **completely** before doing what it tells you to do.

- 1 Make sure the drain valve is closed.
- 2 Put enough shortening in the kettle to completely cover the burner tubes, thermocouple, and high-temperature limit control probe. Use one of these 3 methods:

- \* If you have a Belshaw EZMelt shortening melter-filter, warm the shortening and then transfer it to the kettle. (For EZMelt operating instructions, refer to the EZMelt operator's manual)

### WARNING

**Hot shortening causes severe burns.**

- \* Melt shortening in a pan on the stove and pour it into the kettle.
- \* Put solid shortening into the kettle, packing it tightly around the burner tubes.

### WARNING

**Air spaces can cause the shortening to overheat and catch on fire.**

### CAUTION

**To avoid severe damage to the kettle, never turn on the heat unless the heat tubes are completely covered by liquid.**

3. Move the on/off switch to the OFF position.
4. Rotate the gas control knob counterclockwise to the ON position.
5. Move the on/off switch to the ON position.

The yellow pilot light near the on/off switch and the red pilot light on the fryer cabinet will both light up.

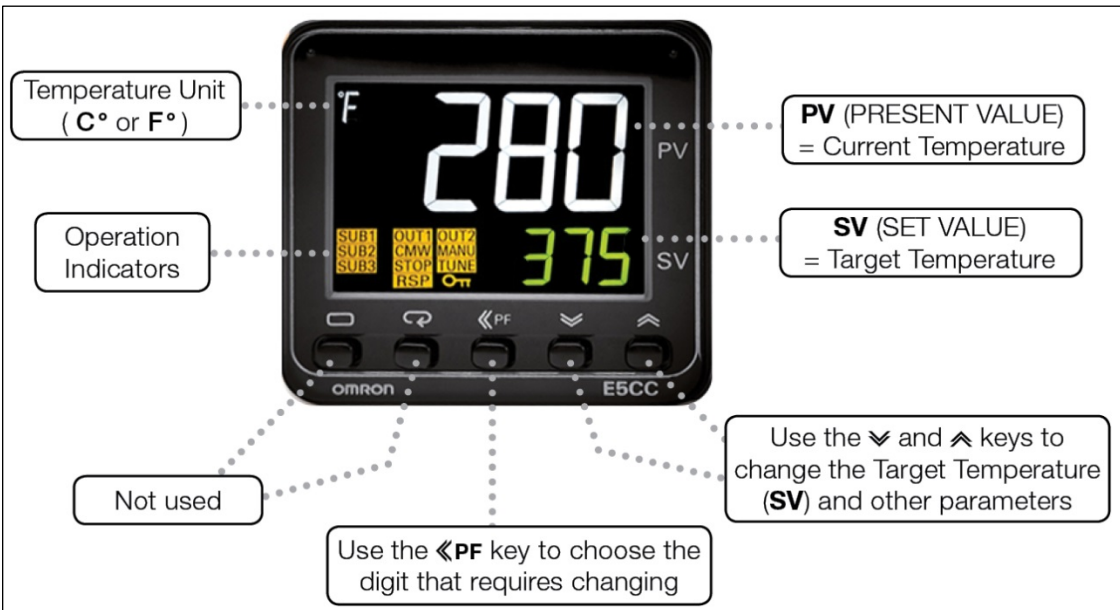

Above: OMRON Digital Temperature Controller

6. (See diagram above) On the digital temperature controller, push the up and down arrow keys to adjust the target frying temperature (SV). A common target frying temperature is 375°F (190°C).

## If the Pilot Light Fails to Ignite

If the pilot fails to ignite within a certain length of time, the gas system will go into safety lock-out. If this happens, move the on/off switch to OFF, wait at least one minute, and then move the on/off switch to ON again.

### **WARNING**

**Failure to wait at least one minute for the gas to dissipate could result in a fire or an explosion when the pilot is lighted again.**

## High Temperature Limit Switch

If the shortening temperature exceeds 435°F/224°C, the high-temperature limit control will break the circuit, and the electrical and gas systems will shut off.

If this happens, follow these steps to reset the system:

- Move the on/off switch to the OFF position.
- Wait for the shortening to cool to 385°F/196°C or below. You will not be able to ignite the pilot until the shortening reaches this temperature.
- Push the red High Limit Reset Button located just above the temperature controller.
- Move the on/off switch to the ON position.

## Adding Shortening to the Fryer

Continue adding shortening to the kettle until it reaches the proper depth for frying. Use one of the following methods. For safety reasons, we recommend the first method, and discourage you from using any other method.

### **WARNING**

**To avoid serious burns, be very careful not to splatter hot shortening when you add shortening to the kettle.**



- \* If you have a Belshaw EZMelt shortening melter-filter, warm the shortening and then transfer it to the kettle. (For EZMelt operating instructions, refer to the EZMelt operator's manual)
- \* Melt shortening in a pan on the stove and pour it into the kettle.
- \* Very carefully put solid shortening into the kettle.

Because shortening expands as it increases in temperature, put shortening in the kettle gradually. Let the shortening in the kettle heat up before you add more.

### **WARNING**

**To avoid serious burns, when the fryer is operating, do not touch the flue, exhaust manifold, stacks, gas burners, or any part of the fryer that is in contact with hot shortening. Keep clear from the area above the flue outlet.**

Wait for the shortening to reach the desired temperature.

## **Fill up to "OIL LEVEL"** **Marks**

Continue supplying shortening to the kettle as required. Keep the kettle filled up to the "Oil Level" marks on the side.

When you have finished frying, move the on/off switch to the OFF position.

# 2

# Cleaning

For your safety, observe the following warnings throughout the entire cleaning process.

## WARNING

**Thoroughly clean and dry the floor if shortening, water, or other materials are spilled. Materials spilled on the floor can cause serious injury or loss of life.**

## WARNING

**To avoid electrocuting yourself or damaging the machine, never allow water, steam, shortening, cleaning solution, or any other liquid to enter the electrical box.**

## WARNING

**To avoid serious burns while cleaning, do not touch the flue, exhaust manifold, stacks, gas burners, or any part of the fryer that is in contact with hot liquids.**

There are four basic steps to cleaning the fryer: removing the shortening, washing, rinsing, and drying. You must perform all four steps and perform them in the order listed.

## Removing the Shortening

## WARNING

**To avoid being burned or electrocuted, disconnect the fryer from the power source before cleaning it.**

1. Disconnect the machine from the power source.
2. Let the shortening cool to 250°F(120°C).
3. Place a Belshaw EZMelt Filter under the drain valve of the fryer. (See your EZMelt Operator's Manual)

## WARNING

**Do not use a plastic container. If the shortening is not cool enough, the container will melt, possibly causing you to be burned, and causing shortening to get on the floor.**

4. Open the drain valve by turning the drain valve extension knob on the side of the fryer cabinet. Allow all the shortening to drain into the EZMelt.

## WARNING

**Do not allow the shortening to overflow the containers. Shortening will get on the floor, and if the shortening is not cool enough, you may be burned.**

## WARNING

**Thoroughly clean and dry the floor if shortening is spilled. Shortening on the floor can cause serious injury or loss of life.**

6. Using a non-abrasive, non-metallic spatula, scrape the sediment and any remaining shortening into the drain valve.

## WARNING

**To avoid fire, serious injury, and equipment damage, do not attempt to burn carbon off of the heat tubes.**

7. Close the drain valve.

## Washing

1. Pour hot water into the kettle, up to the normal level of the shortening. Add trisodium phosphate or another appropriate cleaner.

## CAUTION

**To avoid severe damage to the kettle, never turn on the heat unless the heat tubes are completely covered by liquid.**

2. Connect the fryer to the power source. Move the on/off switch to ON. Set the temperature control to 200°F/93°C. Keep the cleaning solution at this temperature for 15-20 minutes.
3. Scrub the soiled parts while the solution is hot. Do not use any abrasive cleaners or scrapers.

## WARNING

**To avoid being burned, be very careful as you work with hot cleaning solution. Never put your hands in the solution. Wear gloves and long sleeves in case any solution splashes.**

4. Move the on/off switch to OFF and disconnect the fryer from the power source. Allow the cleaning solution to cool to 100°F/38°C.
5. Place a large metal container under the drain valve.

## WARNING

**Do not use plastic containers. If the cleaning solution is not cool enough, the containers will melt; possibly causing you to be burned, and causing cleaning solution to get on the floor.**

6. Open the drain valve and allow the cleaning solution to drain into the container.
7. Watch the container to make sure the cleaning solution does not overflow. If the container becomes full, close the drain valve, put another large metal container under the drain valve, and open the drain valve again.

## WARNING

**Do not allow the cleaning solution to overflow the containers. Cleaning solution will get on the floor, and if the solution is not cool enough, you may be burned.**

8. When the draining is complete, close the drain valve.
9. Carefully carry the container(s) to the sink and slowly pour the solution into the sink.

## WARNING

**Thoroughly clean and dry the floor if cleaning solution is spilled. Liquid on the floor can cause serious injury or loss of life.**

## Rinsing

1. Pour clean water into the kettle, up to the normal level of the shortening. If the cleaner you have used requires that you add a neutralizer, do so now.

### CAUTION

**To avoid severe damage to the kettle, never turn on the heat unless the heat tubes are completely covered by liquid.**

2. Connect the machine to the power source. Move the on/off switch to ON. Set the temperature controls at 200°F/93°C. Leave the water at this temperature for 5-10 minutes.
3. Move the on/off switch to OFF and disconnect the machine from the power source. Allow the water to cool to 100°F/38°C.
4. Place a large metal container under the drain valve.

### WARNING

**Do not use plastic containers. If the water is not cool enough, the containers will melt; possibly causing you to be burned, and causing water to get on the floor.**

5. Open the drain valve and allow the water to drain into the container.
6. Watch the container to make sure the water does not overflow the container. If the container becomes full, close the drain valve, put another large metal container under the drain valve, and open the drain valve again.

### WARNING

**Do not allow the water to overflow the containers. Water will get on the floor, and if the water is not cool enough, you may be burned.**

7. When the draining is complete, close the drain valve.
8. Carefully carry the container(s) to the sink and slowly pour the water into the sink.

### WARNING

**Thoroughly clean and dry the floor if water is spilled. Water on the floor can cause serious injury or loss of life.**

9. Dry the kettle, drain valve, and burner tubes thoroughly. Make sure there is no water in the drain or drain tube.

### WARNING

**Dry all parts of the fryer thoroughly. Failure to dry the fryer and kettle completely will cause an eruption. Shortening will overflow the sides of the fryer and may result in fire, injury, or death.**

# 3

# Donut-Making Helps

## Tips on Making Quality Cake Donuts

- Use the correct batter temperature.  
In general, the correct batter temperature is 75°-80°F/24°-27°C. Check the mix manufacturer's instructions, as the recommended temperature range may vary.  
If the batter is too warm, the donuts will lack volume and may "ring out" or be misshapen. If the batter is too cold, the donuts will stay under the shortening too long, fry too slowly, and crack open or ball up. They may also absorb excess shortening and lose volume.
- Use the correct floor time.  
A floor time of 10 minutes between mixing and cutting allows the baking powder to react with the water. This helps the donuts attain the proper volume the proper level of shortening penetration.  
If the floor time exceeds 30 minutes, the mix will gas off, the donuts will lose volume and shape and will absorb too much shortening.
- Use the correct frying temperature.  
The correct shortening temperature for frying is 370°-380°F/188°-193°C.  
If the shortening is too hot, the donuts will fry too quickly on the outside and will lose volume. The donuts may also become dense inside.

If the shortening is too cold, the donuts will spread too rapidly, will form large rings, will tend to crack open, will be too light in appearance, and will absorb too much shortening.

- Maintain the proper shortening level. We recommend a distance of 1 1/4" between the cutter and the shortening.

If the shortening is too deep, the donuts may not turn over when they reach the turner, causing them to cook unevenly.

If the shortening is too shallow (too far below the cutter), the donuts may not drop flat, may turn over while submerging and surfacing, and may become irregular, cracked, or rough-cruled.

- Ensure that the donuts absorb the right amount of shortening.

Donuts should absorb 1-1/2 to 3 oz/42 to 85 g of shortening per dozen, depending on their weight. You can achieve proper absorption by following tips 1-3.

- If the donuts do not absorb enough shortening, they will not keep well.

If they absorb too much shortening, they will lose volume and may become misshapen. If this happens, follow tips 1-3, mix the batter a little longer than usual, turn the donuts as soon as they become golden brown, and turn the donuts only once.

# Calculating Correct Water Temperature

The following is an example of how to calculate the correct water temperature to use. You must

use your own room temperature, dry mix temperature, desired batter temperature, and, if you are making yeast-raised donuts, estimated temperature increase during mixing.

	<b>Cake Donuts</b>		<b>Yeast-Raised Donuts</b>	
	°F	°C	°F	°C
Room temperature	72	22.2	72	22.2
Dry mix temperature	<u>+70</u>	<u>+21.1</u>	<u>+70</u>	<u>+21.1</u>
<b>Total A</b>	142	43.3	142	43.3
Desired batter temperature	75	23.9	80	26.7
	<u>x3</u>	<u>x3</u>	<u>x3</u>	<u>x3</u>
<b>Total B</b>	225	71.7	240	80.1
<b>Total B</b>	225	71.7	240	80.1
<b>-Total A</b>	<u>-142</u>	<u>-43.3</u>	<u>-142</u>	<u>-43.3</u>
Desired water temp. for cake donuts	<b>83°F</b>	<b>28.4°C</b>	98	36.8
			↓	↓
			Figure from above	
			98	36.8
Temperature increase during mixing (average: 30°F/17°C)			<u>-30</u>	<u>-17</u>
Desired water temperature for yeast-raised donuts			<b>68°F</b>	<b>19.8°C</b>

# Ratios of Plunger Sizes to Donut Weights

The weights given are for donuts without icings or other toppings. They are provided for reference only, as weights vary according to the density of the batter.

<b>Plunger Size</b>	<b>Donut Weight per Dozen</b>
1"	5-8 oz/142-227 g
1 5/8"	14-17 oz/397-482 g
1 3/4"	16-20 oz/454-567 g
1 7/8"	19-24 oz/539-680 g
2"	22-27 oz/624-765 g

# Temperature Conversion

To convert temperatures from Fahrenheit to Celsius, subtract 32 from °F and divide the result by 1.8. For example,  $212^{\circ}\text{F} - 32 / 1.8 = 100^{\circ}\text{C}$ . To convert temperatures from Celsius to Fahrenheit, multiply °C by 1.8 and add 32 to the result. For example,  $(100^{\circ}\text{C} \times 1.8) + 32 = 212^{\circ}\text{F}$ .

°F	°C	°F	°C
55	12.8	340	171.1
60	15.6	345	173.9
65	18.3	350	176.7
70	21.2	355	179.4
75	23.9	360	182.2
80	26.7	365	185.0
325	162.8	370	187.8
330	165.6	375	190.6
335	168.3	380	193.3

*Belshaw*<sup>®</sup>

Open Kettle Gas Fryers  
718LCG, 724CG & 734CG

Technical Supplement

Belshaw Adamatic Bakery Group.

814 44<sup>th</sup> Street Northwest, Suite 103

Auburn, WA 98001 USA

Phone: (206) 322-5474 • Fax: (206) 322-5425

E-mail: [service@belshaw.com](mailto:service@belshaw.com) • <http://www.belshaw.com>

# Table of Contents

<b>Preface</b>	<b>iv</b>
<b>1 Installation</b>	<b>1</b>
Conforming to Codes	1
Selecting a Workstation	1
Unpacking the Fryer	2
Initial Cleaning	2
<b>Assembling the Fryer</b>	2
<b>Installing the Fryer</b>	3
<b>Moving the Fryer</b>	4
Mounting the Drain Tray	5
Assembling the Frying Screen Handles	6
<b>2 Maintenance</b>	<b>7</b>
Open Kettle Temperature Controller Programming procedure (Service Bulletin SB-0439-R3)	7
<b>3 Troubleshooting</b>	<b>11</b>
<b>4 Pilot Module</b>	<b>12</b>
Checkout	12
<b>Step 1: Perform Visual Inspection</b>	12
<b>Step 2: Review the Normal Operating Sequence</b>	12
Trial for Ignition	12
<b>Main Burner Operation</b>	13
<b>Step 3: Reset the Module</b>	13
<b>Step 4: Check Safety Shutoff Operation</b>	13
<b>Step 5: Check Normal Operation</b>	15
Troubleshooting—General	15
Troubleshooting the Ignition System	15
<b>5 Appendix</b>	<b>18</b>



# Preface

The 718LCG, 724CG, and 734CG Gas Fryers are designed to fry cake and yeast-raised donut products. Each must be bolted to a flat, dry floor. The operator should stand opposite the flue stack.

The operator must work safely at all times and read this manual and follow its instructions and warnings. A thorough understanding of how to install, maintain, and safely operate the fryer will prevent production delays and injuries.

Heed the following warnings and all other warnings that appear in this manual:

- Make sure the machine is bolted securely to the floor. Doing so will prevent the machine from moving, tipping, or falling, which could cause serious injury.
- Never let water and hot shortening come in contact with each other. Moisture causes hot shortening to spatter, which may cause serious burns.
- Do not overfill the kettle with shortening. If shortening overflows the kettle, it could cause serious burns or could cause someone to slip on the floor and be seriously injured.
- Hot shortening can cause serious burns. Make sure that the system and the shortening are cool before attempting any cleaning, adjustment, disassembly, or repair.
- To avoid electrocution or other injury, unplug the machine before attempting any cleaning, adjustment, disassembly, or repair.
- To avoid damaging the machine, never use force to assemble, disassemble, operate, clean, or maintain it.
- Be careful never to get shortening, water, or other materials on the floor. If anything does

get spilled on the floor, mop it up immediately. Materials on the floor can cause people to slip or fall, resulting in serious injury or loss of life.

- To prevent unintentional startup and possible fire, unplug the machine if there is a local power outage. When the power is restored, it is safe to plug the machine in again.
- To avoid electrocution, make sure that all electrical cords are not frayed or cracked and that they do not pass through any water or shortening.
- Make sure that all electrical cords are routed so that no one will trip over them.
- Make sure you are aware of the following:

This product contains chemicals known to the State of California to cause birth defects or other reproductive harm. Operation, installation and servicing of this product could expose you to carbon monoxide if not adjusted properly. Inhalation of carbon monoxide is known to the State of California to cause birth defects or other reproductive harm.

Maintenance and repairs shall only be carried out by a factory representative or qualified service personnel.

- Liquid Propane fryers  
Liquid propane models are designed for use with a secure commercially installed propane tank located remotely from your fryer. Do not use with a portable propane tank.
- LPG/LNG Conversion  
Contact the Factory to obtain necessary parts and instructions.

# 1

# Installation

In a prominent location, post instructions to be followed in the event the user smells gas. Obtain this information by consulting your local gas supplier.

## FOR YOUR SAFETY

**Do not store or use gasoline or other flammable vapors or liquids in the vicinity of this or any other appliance.**

## WARNING

**Improper installation, adjustment, alteration, service or maintenance can cause property damage, injury or death. Read the installation, operating and maintenance instructions thoroughly before installing or servicing this equipment.**

## Conforming to Codes

The installation of this fryer must conform with local codes, or in the absence of local codes, with the National Fuel Gas Code (ANSI Z223.1-1992), with the Natural Gas Installation Code (CAN/CGA-B149.1), or with the Propane Installation Code (CAN/CGA-B149.2), including:

- The fryer and its individual shutoff valve must be disconnected from the gas supply piping system during any pressure testing of that system at test pressures in excess of 13.0 IWC (3.45 kPa).
- The fryer must be isolated from the gas supply piping system by closing its individual manual shutoff valve during any

pressure testing of the gas supply piping system at test pressures equal to or less than 13.0 IWC (3.45 kPa).

- Propane fueled fryers must be used with a secure commercially installed propane tank located remotely from your fryer. Do not use with a portable propane tank.

The fryer, when installed, must be electrically grounded in accordance with local codes, or in the absence of local codes, with the National Electrical Code, ANSI/NFPA 70, or with the Canadian Electrical Code, CSA C22.1, as applicable.

## WARNING

### Electrical Grounding Instructions

**This appliance is equipped with a three-prong (grounding) plug for your protection against shock hazard and should be plugged directly into a properly grounded three-prong receptacle. Do not cut or remove the grounding prong from this plug.**

## Selecting a Workstation

The room in which the fryer is to be used should provide enough air for combustion. A ventilation hood with grease filters must be used with the fryer. The hood must be installed and operated in conformance with all applicable fire codes and emissions standards

Maintain these clearances between the sides and back of the fryer to any combustible materials.

- Sides – 2 inches
- Back – 2 inches

The workstation should allow at least 2<sup>2</sup>/<sub>5</sub> cm clearance between the machine and all construction, whether combustible or noncombustible. In addition, it should allow access to the rear of the fryer for cleaning and servicing.

## Unpacking the Fryer

1. Use a fork lift to transport the shipping crate to the work station.
2. Break down the shipping crate.
3. Remove all the packing materials from the fryer. These include foam, tape, brown paper, plastic, and white protective coating.
4. Position the fryer to allow sufficient space on either end of the machine for any equipment you plan to use with it.

## Initial Cleaning

Clean your fryer before using it. Wipe the inside of the kettle with a soft, damp cloth. Dry the kettle thoroughly.

### **WARNING**

**To avoid electrocuting yourself or damaging the machine, never allow water, steam, cleaning solution, or other liquid to enter the electrical box.**

### **WARNING**

**Never let water and hot shortening come in contact with each other. Moisture causes hot shortening to spatter, which may cause serious injury. Prior to use, make sure the kettle and any other parts you have washed are dry.**

## Assembling the Fryer

1. Install the flue stack as follows:

- a. Slide the flange on the bottom of the flue stack underneath the retaining strip on the flue base. The mounting holes must line up. (See Figure 1-1.)
- b. Fasten the flue stack to the flue base using the two pan-head sheet metal screws provided.

Figure 1-1. Installing the Flue Stack.

2. Attach the heat shield to the splash shield as

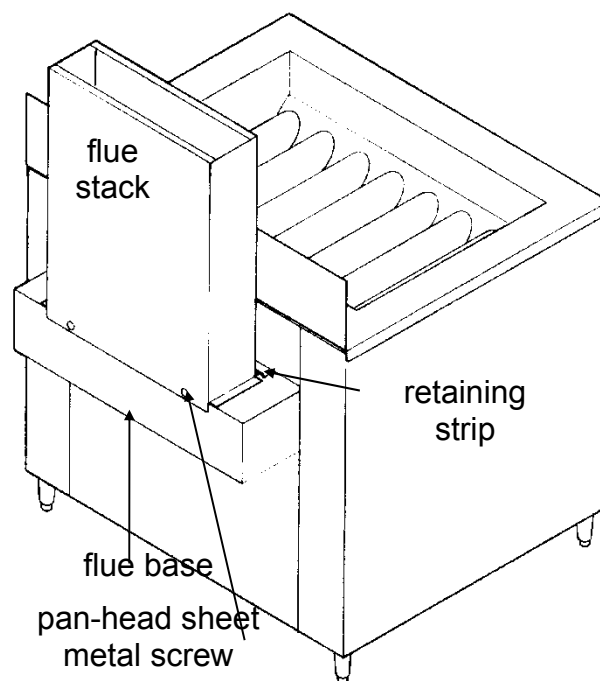

follows:

- a. Slide the flanges on the sides of the heat shield under the bent edges of the splash shield. The mounting holes must line up.
  - b. Fasten the heat shield to the splash shield using the 10-24 x 3/8" hex-head screws, lockwashers, and nuts provided. The screws go through the front of the splash shield; the lockwashers and nuts go on the back of the heat shield.
3. Put the heat shield and splash shield on the fryer. They slide over the flue stack, and the back of the kettle slides between the heat shield and the splash shield. The mounting

holes in the heat shield and the fryer cabinet must line up. See Figure 1-2.

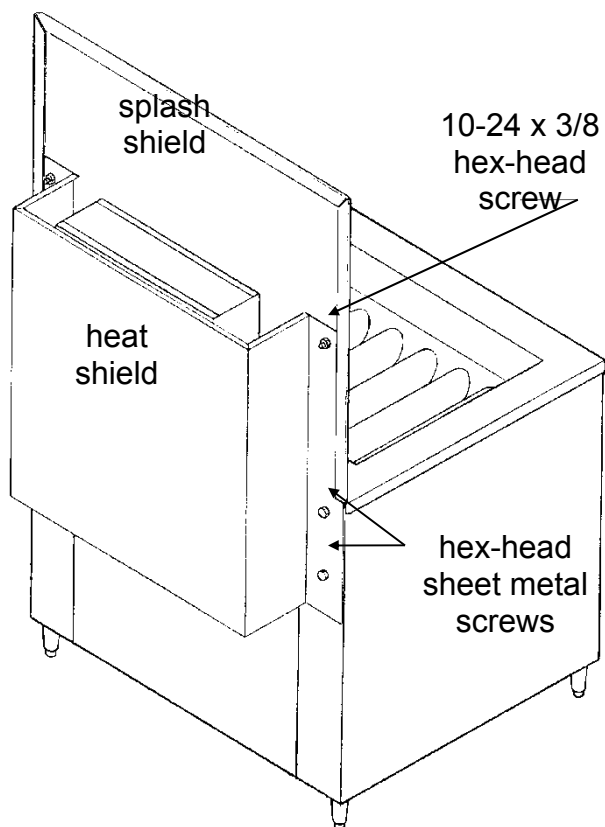

Figure 1-2. Installing the Heat Shield and Splash Shield.

4. Fasten the heat shield to the fryer cabinet using the four hex-head sheet metal screws provided.

## Installing the Fryer

1. Make sure the power requirements of the machine, found on the data plate, match your power source.
2. Using a fork lift or pallet jack, lift the fryer cabinet and screw each leg in as far as it will go.
3. Set the fryer cabinet on a flat, dry floor.
4. Level the fryer. Follow these steps:
  - a. Check to see if the fryer is level. To do so, place a level across the top of the fryer cabinet.

- b. If the fryer is not level, lift the fryer using a fork lift or pallet jack, and turn the legs to adjust them.
  - c. Using the fork lift or pallet jack, lower the fryer to the floor. Be sure that all the legs rest on the floor when the fryer is level.
5. Bolt the fryer to the floor. The foot of each leg has two holes in it for this purpose.

### **WARNING**

**To avoid serious burns, other injury, or death, make sure the fryer is securely fastened to the floor so it will not tip or fall over.**

- 6. If you want to perform pressure testing on the building's gas supply system at pressures greater than 13.0 IWC (3.45 kPa), do so now, before you connect the fryer to the gas supply.

### **CAUTION**

**To avoid damaging the fryer, do not perform pressure testing on the building's gas supply system at pressures greater than 13.0 IWC /3.45 kPa when the fryer is connected to the that system.**

7. Connect the fryer to the gas supply, as follows:
  - a. Make sure the gas line to the fryer is the right size. If it is too small, the gas pressure at the burner manifold will be too low, resulting in slow heat recovery, delayed ignition, and pilot outage. (The gas supply line on the fryer itself is 1/2"/1.3 cm I.P.S.)
  - b. Connect the fryer to the building's gas supply.
  - c. Seal all threaded joints between gas pipes with pipe joint compound. You

must use a compound that resists the action of liquefied petroleum (LP) gases.

- d. Bleed the gas lines of all air.
- e. Check all gas connections and fittings for leaks using a gas leak detector, a soap solution, or a similar substance. When such a substance is applied to connections and fittings, bubbles indicate gas leaks.

**WARNING**

**To avoid a fire or an explosion which would cause serious burns or death, never use an open flame to check connections for gas leaks.**

- 8. If you want to perform pressure testing on the building's gas supply system at pressures at or below 13.0 IWC /3.45 kPa, you may do so now. Before testing, make sure the fryer's individual manual shutoff valve is closed.
- 9. Connect the fryer to a properly grounded power source.

**WARNING**

**This appliance is equipped with a three-prong (grounding) plug for your protection against shock hazard and should be plugged directly into a properly grounded three-prong receptacle. Do not cut or remove the grounding prong from this plug.**

## **Moving the Fryer**

If you ever want to move the fryer to a different workstation, follow this procedure:

- 1. Turn off the fryer and disconnect it from the power source.
- 2. Disconnect the machine from the gas supply.

- 3. Allow the machine and the shortening to cool.

**WARNING**

**Do not touch hot shortening. It can cause serious burns.**

- 4. Remove the shortening from the fryer as explained in "Removing the Shortening" in Section 3.

**WARNING**

**To avoid burns, falls, other injury, or death, never attempt to move the fryer when it has shortening or other liquid in it.**

**WARNING**

**Thoroughly clean and dry the floor if shortening is spilled. Materials on the floor can cause people to slip or fall, resulting in serious injury or loss of life.**

- 5. Remove the bolts that secure the fryer to the floor.
- 6. Using a fork lift, transport the machine to the new workstation.
- 7. Level the fryer, bolt it to the floor, connect it to the gas line, and connect it to the power source, as explained in "Installing the Fryer" above.

## Mounting the Drain Tray

The drain tray is mounted on the right side of the fryer in the factory. To move the drain tray on the left side, see the diagram below and follow these steps.

1. Remove the acorn nut from the back side of the drain tray hinge shaft (Diagram ①)
2. Slide the drain tray hinge shaft out of the drain tray mounting brackets (Diagram ②)
3. Lift off the drain tray.
4. Remove the two drain tray support brackets that are mounted on the right side of the cabinet (Diagram ③)
5. Install the drain tray support brackets on the left side of the cabinet. Each bracket is held in place by two hex-head machine screws, two hex nuts, two internal tooth lock washers, and two flat washers. Tighten all of these securely.
6. Put the drain tray in place on the left side of the fryer. The holes on the drain tray should line up with the holes in the mounting brackets on the left side.
7. Slide the drain tray hinge shaft through the holes in the mounting brackets and the drain tray.
8. Tighten the acorn nut (removed in step 1) on the end of the drain tray hinge shaft.
9. Lift the drain tray support rod (Diagram ④) so it is held in place by the support brackets installed on the left side in Step 5.

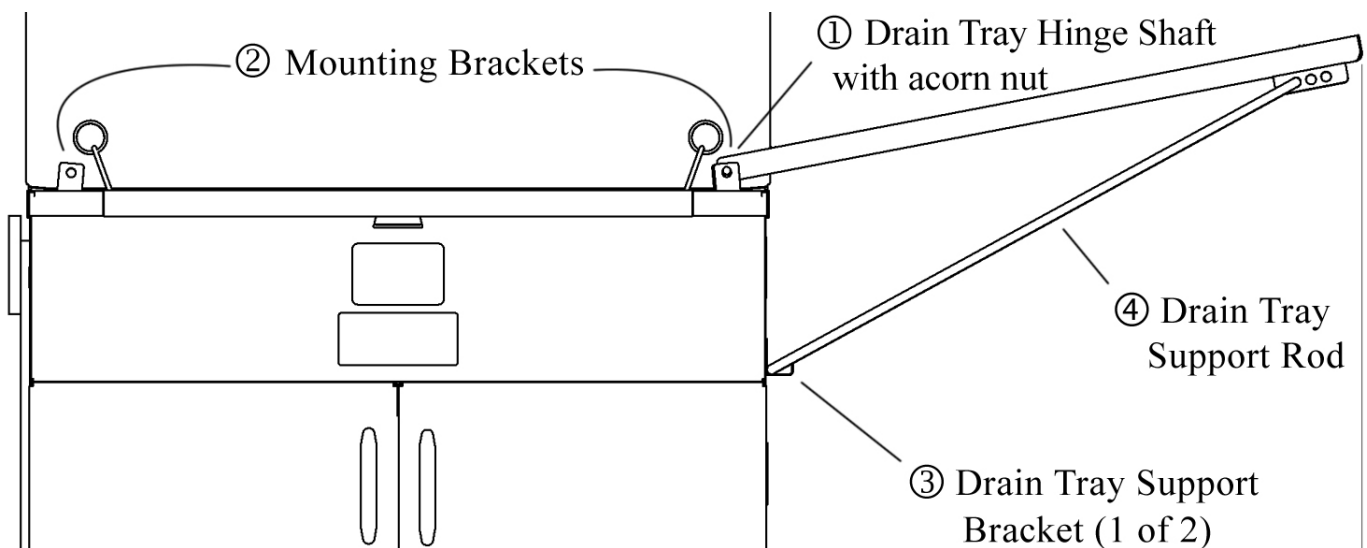

## **Assembling the Frying Screen Handles**

*(Be aware that you may be using detachable handles rather than fixed handles, particularly when making raised donuts using screens which are placed inside a proofer. In this case, your handles should NOT be attached to screens.)*

Frying Screens come with handles and hardware unassembled. When assembled the location of the handles should be as follows:

- For Model 618L and 718L Fryers, center the handles along the long sides of the screen.
- For Models 624 and 724, center the handles along any opposing sides of the screen.
- For Models 634 and 734, center the handles along the short sides of the screen.

To assemble Frying Screens, refer to Figure 1-3 opposite.

1. Install #10-32 Nuts (B) on threaded handle rods (A).
2. Locate clips (D) on the screen (C). Center the handles as listed above for each type of fryer.
3. Insert threaded end of handle (A) with handle to outside as shown, making sure that the spacer (E) is in place.
4. Install #10-32 nuts (F) flush onto threaded end of handle (A)
5. Tighten #10-32 Nuts (B) locking handle assembly to screen.

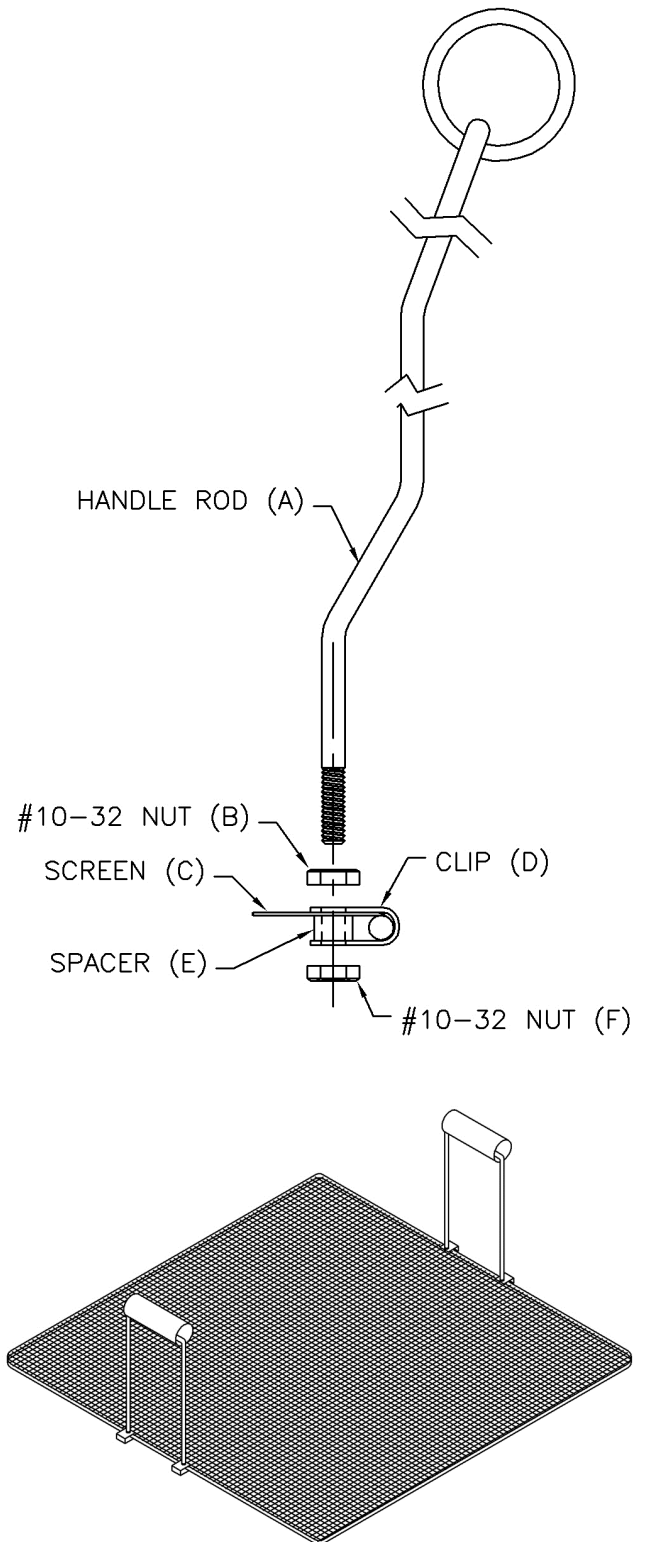

(Above: Figure 1-3)

## **Open Kettle Temperature Controller Programming procedure (Service Bulletin SB-0439-R3)**

This service bulletin covers the proper procedure for programming the Omron E5CC-RX3DM-000 temperature controller in an open kettle fryer. The Belshaw part number is TJ-0184C-2.

This controller is programmed and protected so the operator cannot change the setup parameters. You must first unlock the controller to adjust the settings.

See the following pages for programming procedure.



## Century and Open kettle fryer Temperature Controller Programming procedure

This service bulletin covers the procedure for programming the TJ-0184C-2 (Omron E5CC-RX3DM-000) temperature controller used on Century and Open kettle fryers.

The TJ-0184C-2 controller comes per-programmed and protected so the operator cannot change the setup parameters. To change any setting you must first unlock the controller.

**Note:** Only the settings that are changed from the Factory settings are listed below.

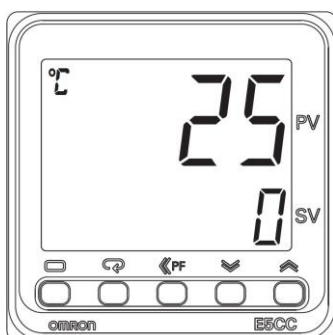

To unlock the controller:

1. Press the + keys for more than 3 seconds
2. Press the key to move to the next parameter
3. Press the or to change the parameter *OPPL* and *ICPL* from 2 to 0
4. Press the + keys for more than 1 second to return to operator screen





Parameter	Factory default setting	Present setting	Unit	Front panel	Explanation of present setting
<b>Protection parameters</b>					
Operation/Adjustment Protect	0	2	.	<i>OPPL</i>	2:Display and change of only "PV" and "PV/SP" parameters is allowed. [2]
Initial Setting/Communications Protect	1	2	.	<i>ICPL</i>	2:Prohibited [2]

To change operator set points: (Must be unlocked to change Alarm Value 1)

1. Press the key to move to the next parameter
2. Press the or to change the parameter
3. Press the key to return to operator screen





<b>Operator set points</b>					
Set Point	0.0	375.0/190.0	°F/°C	.	.
Alarm Value 1	0.0	10.0/5.0	°F/°C	<i>AL - 1</i>	.

To change operator level parameters: (Must be unlocked)

1. Press the  key for less than 1 second
2. Press the  key to move to the next parameter
3. Press the  or  to change the parameter
4. Press the  key to return to operator screen





Operator level parameters					
Process Value Input Shift	0.0	0.0	°F/°C	2N5	<b>This is the offset setting for calibration</b>
Hysteresis (Heating)	1.0	0.5	°F/°C	H45	.



To change initial level parameters: (Must be unlocked)

1. Press the  key for more than 1 second to adjust initial parameters
2. Press the  key to move to the next parameter
3. Press the  or  to change the parameter
4. Press the  key for more than 1 second return to operator screen







Initial level parameters					
Input Type	5	8	.	2N-8	8:Thermocouple[J] (-20.0 to 400.0°C or 0.0 to 750.0°F) [8]
Temperature Unit	0	1/0	.	d-U	°F [F]/ °C [C]
SP Upper Limit	130.0	400.0/200.0	°F/°C	SL-H	.
SP Lower Limit	-20.0	0.0	°F/°C	SL-L	.
Alarm 1 Type	2	7	.	AL1	7:Lower limit alarm with standby sequence [7]
Alarm 2 Type	2	0	.	AL2	0:Alarm function OFF [0]
Alarm 3 Type	2	0	.	AL3	0:Alarm function OFF [0]
Alarm 4 Type	2	0	.	AL4	0:Alarm function OFF [0]

To change advanced level parameters: (Must be unlocked)







1. Unlock the controller
2. Press the  key for more than 1 second to adjust initial parameters
3. Press the  key until you get to parameter  $AM\bar{a}'$
4. Press the  or  to change  $AM\bar{a}'$  parameter to -169

Advanced level parameters					
PV/SP No. 1 Display Selection	4	1	.	SPd 1	1: "PV/SP/No display" [  ]
PV Decimal Point Display	1	0	.	PVdP	OFF [  ]
SV Status Display Function	0	3	.	SVSt	Alarm 1 [  ]

After programming: To lock the controller:

1. Press the  +  keys for more than 3 seconds
2. Press the  key to move to the next parameter
3. Press the  or  to change the parameter  $\bar{a}RPE$  and  $\bar{L}CPt$  from 0 to 2
4. Press the  +  keys for more than 1 second to return to operator screen

To set the controller back to factory default settings: (Must be unlocked, see page 1)

1. Press the  key for more than 1 second to adjust initial parameters
2. Press the  key until you get to parameter  $AM\bar{a}'$
3. Press the  or  to change  $AM\bar{a}'$  parameter to -169
4. Change parameter  $\bar{L}N\bar{L}t$  from  $\bar{a}FF$  to  $FALt$
5. Press the  key for more than 1 second return to initial screen
6. Press the  key for more than 1 second return to operator screen

Please do not hesitate to contact Belshaw Adamatic Bakery Group for additional assistance at (206) 322-5474, (800) 578-2547 or e-mail at [service@belshaw.com](mailto:service@belshaw.com).

# 3

# Troubleshooting

If you have a problem with your fryer that you cannot solve, call your dealer or another qualified technician.

If your dealer cannot help you, please call Belshaw Bros. at (206) 322-5474. When you call, please specify the following:

- \* The model name of the machine.
- \* The serial number of the machine.
- \* The voltage, phase, and cycle of the machine.

## CAUTION

**If you perform repairs yourself or have them performed by anyone other than a service technician authorized by Belshaw Bros., you do so at your own risk.**

## WARNING

**Disconnect the machine from the power source before disassembling, repairing, or wiring.**

This section contains supplemental information about the Honeywell S8600 Intermittent Pilot Module. The Belshaw 718LCG, 724CG, and 734CG gas fryers all use this module. Fryers using natural gas use the S8600F-1000. Fryers using propane use the S8600H-1014.

Belshaw provides this appendix as a courtesy to our customers. We deny any liability for the use of the information contained herein. All of the procedures explained below should be performed by qualified technicians.

## Checkout

### **WARNING**

**To avoid fire or explosion, resulting in property damage, injury, or loss of life, if you smell gas or suspect a gas leak, turn off the gas at the manual service valve and evacuate the building. Do not try to light any appliance or touch any electrical switch or telephone in the building until you are sure no spilled gas remains.**

### **WARNING**

**To avoid fire or explosion, resulting in property damage, injury, or loss of life, perform gas leak tests as explained in Steps 1 and 5 below at the time of initial installation and at any time work is done involving the gas piping.**

### **Step 1: Perform Visual Inspection**

1. Make sure the fryer's on/off switch is in the OFF position. Make sure all wiring connections are clean and tight. If they are not, correct them.
2. Move the on/off switch to ON.
3. Open the manual shutoff valves in the gas line to the fryer.
4. If the piping has been disturbed, perform a gas leak test ahead of the gas control, as follows:
  - a. Paint the pipe joints with a rich solution of soap and water. Bubbles in the solution indicate gas leaks.
  - b. If there are leaks, tighten the joints.
  - c. Test again for leaks.
  - d. Repeat this procedure until no leaks exist.

### **Step 2: Review the Normal Operating Sequence**

#### **Trial for Ignition**

When the fryer's thermostat calls for heat, the module energizes the first main valve operator. The first main valve opens, allowing gas to flow to the pilot burner. At the same time, the electronic spark generator in the module produces a spark pulse output of over 10,000 volts. The voltage generates a spark at the igniter-sensor that lights the pilot.

If the pilot does not light, or if the pilot flame current is not at least 1.0  $\mu$ A and steady, the module will not energize the second main valve, and the main burner will not light. The S8600F, which is used on natural gas fryers, will continue

to spark as long as the fryer's thermostat calls for heat or until the pilot lights.

The S8600H, which is used on propane fryers, provides 100 percent shutoff and safety lockout. Its ignition sparks only for a pre-set length of time (15 or 90 seconds, as stamped on the module). If the pilot does not light within the timed trial for ignition period, the module goes into safety lockout, de-energizing the first main valve operator, closing the first main pilot valve in the gas control, and stopping the flow of gas to the pilot. You must then move the on/off switch to OFF, and wait at least one minute before trying again to light the pilot.

### **Main Burner Operation**

When the pilot flame is established, a flame rectification circuit is completed between the sensor and the burner ground. The flame sensing circuit in the module detects the flame current, shuts off the spark generator, and energizes the second main valve operator. The second main valve opens and gas flows to the main burner, where it is ignited by the pilot burner. On the S8600H, the safety lockout timer is held in the normal operating mode.

When the thermostat no longer calls for heat, both valve operators are de-energized, and both valves in the gas control close.

### **Step 3: Reset the Module**

1. Turn the thermostat to its lowest setting.
2. Wait at least one minute.

### **Step 4: Check Safety Shutoff Operation**

This step applies only to the S8600H, which is used on propane fryers.

1. Turn the gas supply off.
2. Move the on/off switch to ON.

Watch to see whether there is a spark at the pilot burner immediately.

3. Time the spark from the time it starts to the time it shuts off.

4. Compare this time with the shutoff time that is stamped on the module. They should be the same.
5. Open the manual gas cock and make sure that no gas is flowing to the pilot or main burner.
6. Move the on/off switch to OFF and wait at least one minute before continuing.

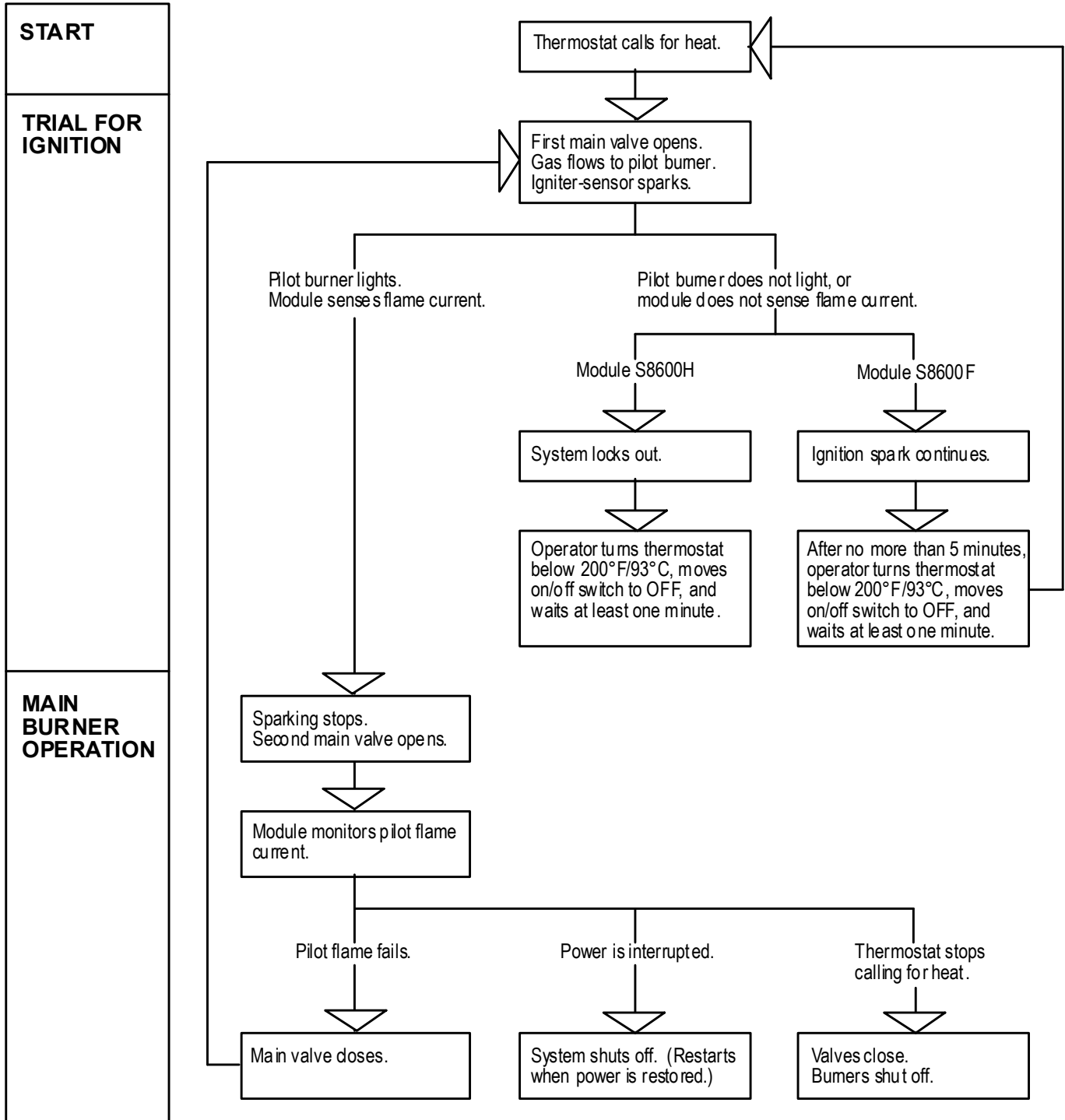

Figure 6-1. Normal Operating Sequence.

## Step 5: Check Normal Operation

1. Move the on/off switch to ON.
2. Set the temperature controller to 200°F (93°C) or higher.
3. Watch to see whether the pilot lights smoothly when the gas reaches the pilot burner.
4. Watch to see whether the main burner lights smoothly without flashback.
5. Watch to see whether the main burner operates smoothly without floating, lifting, flame rollout, or heat buildup.
6. If the gas line has been disturbed, perform a gas leak test, as follows:
  - a. Paint the gas control gasket edges and all pipe connections downstream of the gas control, including pilot tubing connections, with a rich solution of soap and water. Bubbles in the solution indicate gas leaks.
  - b. If there are leaks, tighten the joints or screws, or replace the component.
  - c. Test again for leaks.
  - d. Repeat this procedure until no leaks exist.
7. Move the on/off switch to OFF.
8. Watch to see whether the main burner flame and the pilot flame go out.

## Troubleshooting—General

The following service procedures are provided as a general guide.

For electrical troubleshooting, refer to the diagrams included with this manual or to the diagram on the inside of the fryer door. Heed all warnings and cautions.

- \* On lockout and retry models, meter readings between gas control and ignition module must be taken within the trial for ignition period. Once the ignition module shuts off, lockout

models must be reset by setting the thermostat below 200°F/93°C for at least one minute before continuing. On retry models, wait for retry or reset at the thermostat.

- \* If any component does not function properly, make sure it is correctly installed and wired before replacing it.
- \* The ignition module cannot be repaired. If it malfunctions, it must be replaced.
- \* Only trained, experienced service technicians should service intermittent pilot systems.

As the first step in troubleshooting, perform the checkout procedure. Then check the block diagram. If you think there is an ignition problem, see “Troubleshooting the Ignition System” below to isolate and correct the problem.

Following troubleshooting, perform the checkout procedure again to be sure system is operating normally.

## Troubleshooting the Ignition System

### Step 1: Check Ignition Cable

1. Make sure the ignition cable does not run in contact with any metal surfaces.
2. Make sure the ignition cable is no more than 36”/0.9 m long.
3. Make sure the connections to the ignition module and to the igniter-sensor are clean and tight.
4. Make sure the ignition cable provides good electrical continuity.

### Step 2: Check Ignition System Grounding

Nuisance shutdowns are often caused by a poor or erratic ground.



A common ground, usually supplied by the pilot burner bracket, is required for the module and the pilot burner/igniter-sensor.

1. Check for good metal-to-metal contact between the pilot burner bracket and the main burner.
2. Check the ground lead from the GND (BURNER) terminal on the module to the pilot burner. Make sure the connections are clean and tight. If the wire is damaged or deteriorated, replace it with #14-18 gauge, moisture-resistant, thermoplastic-insulated wire with a 221°F/105°C minimum rating.
3. Check the ceramic flame rod insulator for cracks or evidence of exposure to extreme heat, which can permit leakage to the ground. Replace the pilot burner/igniter-sensor and provide a shield if necessary.

If the flame rod or the bracket are bent out of position, restore them to the correct position.

### Step 3: Check Spark Ignition Circuit

You will need a short jumper wire made from ignition cable or other heavily insulated wire.

1. Close the manual gas valve.
2. Disconnect the ignition cable at the SPARK terminal on the module.

#### WARNING

**To avoid electric shock, when performing the following steps, do not touch the stripped end of the jumper or the SPARK terminal. The ignition circuit generates over 10,000 volts.**

3. Energize the module and immediately touch one end of the jumper firmly to the GND terminal on the module. Move the free end of the jumper slowly toward the SPARK terminal until a spark is established.
4. Pull the jumper slowly away from the terminal and note the length of the gap when sparking stops.

5. Check the table below.

Arc Length	What To Do
No arc, or arc less than 1/8"/3 mm	Check external fuse, if provided. Verify power at module input terminal. Replace module if fuse and power are okay.
Arc 1/8"/3 mm or longer.	Nothing. (Voltage output is okay.)

### Step 4: Check Pilot and Main Burner Light is off

1. Turn the on/off switch to ON.
2. Watch the pilot burner during the ignition sequence. Look for the following:
  - \* The ignition spark continues after the pilot is lit
  - \* The pilot lights and the spark stops, but the main burner does not light
  - \* The pilot lights, the spark stops and the main burner lights, but the system shuts down (S8600H only)
3. If any of these things happens, make sure the flame current is adequate. Follow these steps:
  - a. Turn off the fryer and disconnect it from the power source.
  - b. Clean the flame rod with emery cloth.
  - c. Make sure the electrical connections are clean and tight. Replace damaged wire with moisture-resistant #18 wire rated for continuous duty up to 221°F/105°C.
  - d. Check to see if ceramic insulator is cracked. A cracked insulator can cause a

short to ground. Replace the igniter-sensor if necessary.

- e. At the gas control, disconnect the main valve wire from the TH or MV terminal.
- f. Connect the fryer to the power source and move the on/off switch to the ON position.
- g. Turn on the power and set thermostat above 200°F/93°C to call for heat. The pilot should light, but the main burner will remain off because the main valve actuator is disconnected.
- h. Check the pilot flame. Make sure it is blue, steady, and envelops 3/8-1/2”/ 10-13 mm of the flame rod. See the table below for possible flame problems and their causes.
- i. If necessary, adjust the pilot flame by turning the pilot adjustment screw on the gas control clockwise to decrease or counterclockwise to increase the pilot flame. Following adjustment, always replace the pilot adjustment cover screw and tighten it firmly to assure proper gas control operation.
- j. Move the on/off switch to ON.

4. Recheck the ignition sequence as follows:

- a. Reconnect the main valve wire.
- b. Set the thermostat above 200°F/93°C to call for heat.
- c. Watch the ignition sequence at the burner.

If the spark still does not stop after the pilot lights, replace the ignition module.

If the main burner does not light, check for 24V AC across MV-MV/PV terminals. If there is no voltage, replace the module. Also, check the electrical connections between the module and the gas control. If they are okay, replace the gas control or the gas control operator.

Appearance	Cause
small blue flame	lack of gas due to clogged orifice filter lack of gas due to clogged pilot filter low gas supply pressure pilot adjustment is at minimum
lazy yellow flame	lack of air due to large orifice pilot adjustment is at minimum
waving blue flame	excessive draft at pilot location products of combustion are recirculating
noisy lifting blowing flame	high gas pressure
hard sharp flame	high gas pressure orifice too small

## Belshaw Adamatic Bakery Group Limited Warranty / Return Policy

---

Subject to the terms and limitations set forth in this limited warranty ("Limited Warranty"), Belshaw Adamatic Bakery Group (also referred to as "the Manufacturer") warrants to the original purchaser ("Purchaser") of Manufacturer's equipment and parts ("Products"), Belshaw Adamatic Bakery Group's manufacture and assembly of Products to be free from defects in workmanship and material which would result in product failure under normal use and service. Belshaw Adamatic Bakery Group's entire liability under this Limited Warranty is limited to either repairing or replacing at Manufacturer's factory or on Purchaser's premises, at Belshaw Adamatic Bakery Group's option, any Products purchased by Purchaser which shall be determined by the Manufacturer to be defective. If necessary to return Products to Manufacturer's factory, Products must be shipped by Purchaser with transportation charges prepaid by Purchaser.

Belshaw Adamatic Bakery Group reserves the right to make changes in design or add any improvement to its Products at any time without incurring any obligations to install the same on Products previously sold.

Possession, use or operation of Products sold hereunder for any other than their designed purpose, or use of Products which are in poor repair, modified, improperly operated, or neglected, is done at the Purchaser's risk. Belshaw Adamatic Bakery Group hereby disclaims any liability for these actions and shall not be liable for defects in or for any damages or loss to any property which is attributable to such actions.

**Under no circumstances shall Belshaw Adamatic Bakery Group be liable for any indirect, special, incidental, or consequential damages arising out of, or from the use of its Products by Purchaser, its assignees, employees, agents or customers.**

**THIS LIMITED WARRANTY SHALL BE PURCHASER'S SOLE AND EXCLUSIVE REMEDY WITH RESPECT TO DEFECTIVE PRODUCTS.**

### **Warranty Period**

This Limited Warranty covers Products manufactured by Belshaw Adamatic Bakery Group and sold by Belshaw Adamatic Bakery Group or its authorized distributor ("Distributor") or authorized dealer ("Dealer"), and this Limited Warranty shall extend for a period of one (1) year from date of shipment to Purchaser, and to the original Purchaser only.

### **Limited Warranty**

With respect to products not manufactured by Belshaw Adamatic Bakery Group, warranty coverage shall be limited to the warranty of the original manufacturer of the product, or the Belshaw Adamatic Bakery Group Limited Warranty, whichever is the lesser coverage period.

Replacement Products provided under the terms of this Limited Warranty are warranted for the remainder of the original warranty period applicable to the Product.

### **Exclusions**

This Limited Warranty excludes from its coverage and does not apply to: (a) solenoid and relay coils; (b) lamps; (c) "O" rings; (d) belts; and (e) impellers. This Limited Warranty also excludes the cost of labor for removing and replacing Products subject to a warranty claim, other than the labor incurred directly by the Manufacturer when, in Belshaw Adamatic Bakery Group's opinion, a repair of the Product by the Manufacturer is justified.

## Warranty Claims

In case of warranty claims relating to your Product, you must follow the instructions below.

### Report Claims to Your Authorized Distributor or Dealer or to Belshaw Adamatic Bakery Group

As soon as you discover a problem, contact the Distributor or Dealer from whom you purchased the Product or Belshaw Adamatic Bakery Group. Your Distributor or Dealer will notify Belshaw Adamatic Bakery Group for you. **Only Belshaw Adamatic Customer Service can approve or authorize warranty claims.**

You must state the following:

1. Your name, company name, and telephone number
2. The location, phone number, and contact name where the Product is located
3. The invoice number and date of purchase of the Product
4. The Model and Serial Number of the Product, as written on the data tag attached to the Product
5. A description of the problem and how it occurred

### Shipping Damage and Missing Items

**Damage to the Packaging or Crate.** On delivery, promptly check all packages thoroughly for any sign of damage. In cases of visible damage, **always note the damage on the Delivery Receipt.** Failure to note damage is taken by the Freight Carrier to mean that the package is in good condition at time of receipt, and can result in denial of a Freight Claim. Take photographs that clearly show the damage.

**Damage to Products.** If you find any damaged Product inside the shipment, photograph the damage both inside and outside of the package. Do not throw the packaging away. Photos of the package and contents are needed to show the condition of the Product at the time it was received.

**Missing Items.** As soon as you believe any items to be missing from a shipment, promptly report this to the Distributor or Dealer from whom the Product was purchased or to Belshaw Adamatic Bakery Group. If possible, photograph the entire contents of the delivery and email this to your Distributor or Dealer, or to Belshaw Adamatic Customer Service at [service@belshaw.com](mailto:service@belshaw.com).

### Returning Products to Belshaw Adamatic Bakery Group

Under the terms of the Limited Warranty, you may be asked to return to Belshaw Adamatic Bakery Group any Product that is the subject of a warranty claim. These Products must be clearly labeled with a Return Goods Authorization Number ("RGA Number") given to you by your Distributor or Dealer, or by Belshaw Adamatic Customer Service. Products received without an RGA Number will not be processed. All Products must be shipped freight prepaid by the Purchaser to Belshaw Adamatic Bakery Group at the address below.

### Contacting Belshaw Adamatic Bakery Group

At any time, you can contact Belshaw Adamatic Bakery Group customer service for assistance

Belshaw Adamatic Bakery Group Customer Service

814 44th St. NW, Suite 103,

Auburn WA 98001, USA

Phone: 800-578-2547 (USA/ Canada) or (+1)206-322-5474 (Worldwide)

Email: [service@belshaw.com](mailto:service@belshaw.com)

Office Hours: Monday – Friday, 6am to 4pm, USA Pacific Time



*Belshaw*<sup>®</sup>

**The #1 Source for Donut and Bakery Equipment**

**[www.belshaw.com](http://www.belshaw.com)**

**BELSHAW ADAMATIC BAKERY GROUP  
814 44th Street NW, Suite 103  
Auburn, WA 98001 USA**

**1-800-BELSHAW  
1-800-578-2547 (USA/Canada)  
(+1) 206-322-5474 (Worldwide)**

**[service@belshaw.com](mailto:service@belshaw.com)**

an Ali Group Company



The Spirit of Excellence